



Automatic Hand Dryers

Breeze Hand Dryer
Instructions Manual

Table of Contents

Product Dimensions	3
Product Features, Technical Specifications & Package Contents	4
Installation & Safety Guidelines	5
Installation Instructions	6
Operation Guidelines	8
Cleaning & Maintenance Guidelines	9
Warranty Details	10
Notes	11

Product Dimensions

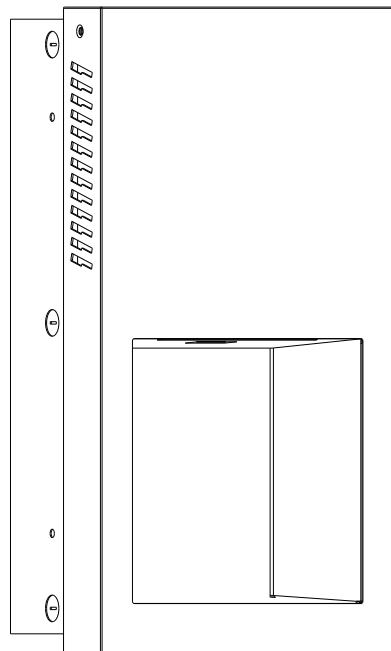
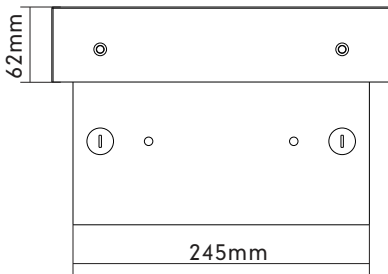
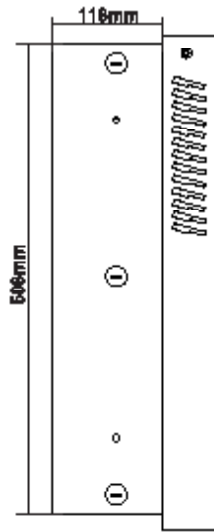
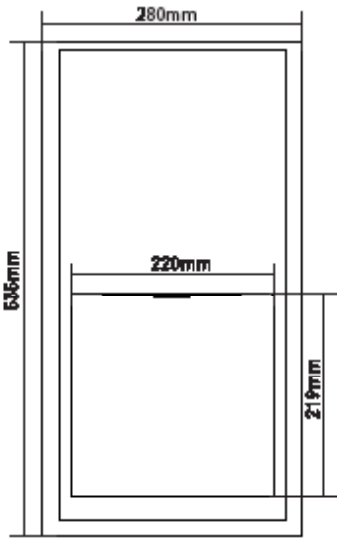

Product Features, Technical Specifications & Package Contents

Product Features:

- Recessed design make this a streamlined and unobtrusive dryer ideal for where space is at a premium.
- 18cm deep alcove that captures and evaporates water thanks to a hygienic absorbent ceramic surface.
- Heavy duty stainless steel casing gives excellent ongoing protection against corrosion and vandalism.
- The automatic 'no touch' operation ensures impeccable hygiene.
- Users enjoy an ultra-fast drying time of just ten seconds!
- Maximum output comes at minimal power consumption to help reduce carbon footprint.
- No unnecessary energy wastage thanks to the automatic cut-off.
- Reduced noise levels make this one of the quietest and most discrete dryers in any class.
- Built in removable HEPA filter for hygienic operation with filtered air.
- Easy to install and maintain.
- Finishes available in Brushed Metal.

Technical Specifications:

- Shell material/s: 304 Stainless Steel
- Standard finishes: Brushed Metal
- Rated voltage: AC 220-240V
- Rated frequency: 50 / 60 Hz
- Rated power: 1,100W
- Installation: recessed wall mounted
- Drying time: 9 seconds
- Air speed: 90 M/s
- Noise output: 75dB
- Operation: infrared automatic 'no touch'
- Timing protection: 60 seconds auto cut off
- Thermal protection: cut off above 70C

- Drip proof: IPX3
- Filter: HEPA filter
- Unit dimensions: 280 W x 535 H x 180 D mm (62mm from surface)
- Net weight: 12.5 kg
- Warranty: 2 Years
- Certification: CE, RoHS

Package Contents:

- Hand dryer
- Fixtures and fittings
- User manual and installation guide

Installation & Safety Guidelines

- All electrical installation and repair work should be carried out by a qualified electrician in accordance with current local codes or regulations.
- Do not attempt any disassembly or modification of the unit that is not expressly stated in this manual.
- Do not install when the product (power cable) is electrified.
- Install securely in a location strong enough to support the weight of the unit.
- Install the hand dryer on a smooth surface and in an area where people are not likely to collide with the object once installed.
- Do not scratch, damage, process, excessively bend, pull, twist or bundle the power cable, and do not place heavy objects onto it or trap it.
- Do not use in a hot location such as a shower room, where condensation may form on the unit, or where water may splash directly at the unit.
- Do not install this hand dryer above sources of water such as sinks or taps.
- Do not install in locations where salt damage may occur, or where corrosive, neutral, or reductive gases are present.

Installation Instructions

1) Remove dryer cover:

- Loosen the dryer cover by removing the mounting screws located at the bottom and sides of the unit.

2) Remove dryer body:

- Use a Phillips screwdriver (over 150mm long) to loosen the screws and remove the hand dryer body.

3) Create recess & prepare framework:

- Prepare recess in wall: 248mm W x 510mm H x 119mm D.
- As shown in the diagram, drill holes at the corresponding positions and insert the wall plugs (4 in total) into the holes.
- Use a slotted screwdriver to line up the electrical supply entry hole and then insert the wires.
- Place the metal framework into the wall and tighten the fixings.

4) Fit dryer body:

- Place the dryer body back into the framework and using a Phillips Screwdriver tighten the screws to fix the hand dryer body.

5) Connect wiring:

- Connect wiring to the terminal connector.

6) Replace dryer cover:

- Place the dryer cover slowly onto the framework.

7) Check everything lines up:

- The sensor and the air outlet should be aligned with the position on the cover.
- Tighten mounting screws and fix cover in place.

Recommended Mounting Heights

Measurements are from the bottom of the recessed framework to the floor:

- Mens / Ladies: 900mm
- Disabled / Children: 750mm

1)

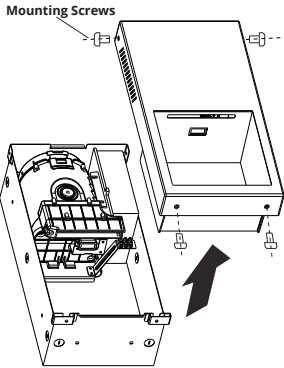

2)

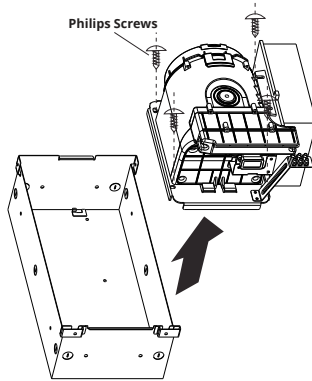

3)

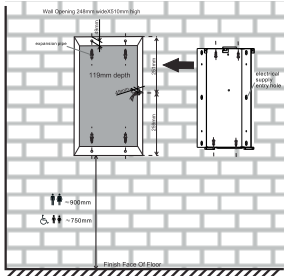

4)

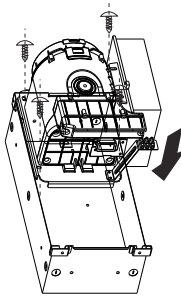

5)

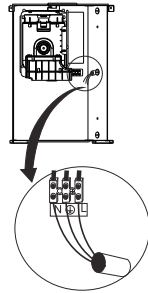

6)

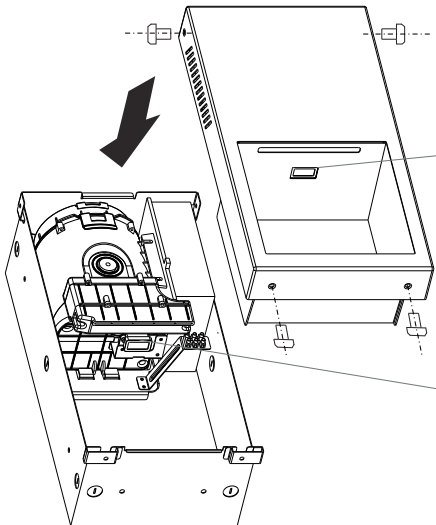

7)

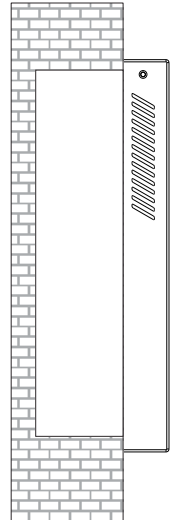

Operation Guidelines

1. Before inserting hands under the dryer, shake off any excess water.
2. This hand dryer incorporates no touch sensor activation for hygienic use. Simply place your hands within the air outlet compartment and the hand dryer will be automatically activated.
3. Remove your hands away from the air outlet and the hand dryer will be deactivated after 2 seconds.
4. The hand dryer will automatically cut off after running for 60 seconds if the sensor is activated for this period. If need be, remove hands from the sensor and return your hands and the dryer will re-activate.

1

Insert hands into dryer face down, slowly move hands back and forth.

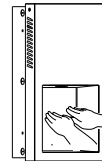

2

Turn hands over, again slowly move hands back and forth.

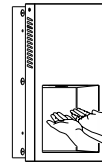

3

Finally rub hands together whilst in dryer.

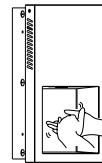

Cleaning & Maintenance Guidelines

Cleaning and maintenance should be carried out by service personnel only, after ensuring that the unit is disconnected from the power supply. It is recommended that cleaning be carried out regularly every week.

A) Cleaning the unit body

1. Simply wipe down the exterior of the dryer with a damp cloth, removing any build up dirt, paying particular attention to the sensor.

B) Maintenance of absorbent ceramic surface

1. Remove the security fixings and lift off the outer casing.
2. Slide out ceramic plate from rear of casing.
3. Wash ceramic plate with warm soapy water and remove any soap residue before drying with a clean cloth.
4. Avoid cleaning with products that contain bleach, hydrochloric acids or chlorides.
5. Avoid stainless steel cleaner from making contact with ceramic as it can stain ceramic. Avoid use of oily cleaners to prevent ceramic pores from clogging.
6. Avoid use of steel wool which can scratch surface.
7. Replace ceramic plate and refit outer casing.

C) Cleaning the air filter

1. Remove the air filter component.
2. For a light clean – use a vacuum cleaner to remove any build of dirt. For a more thorough clean – soak the air filter in warm water.
3. Replace the air filter back within the body.

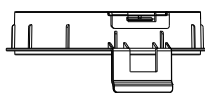
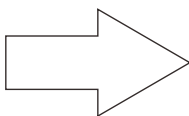
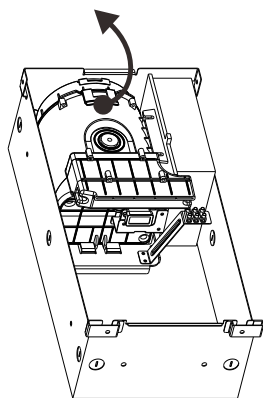

It is suggested to replace the filter every 6 months.

Warranty Details

- All Tekflo Hand Dryers are guaranteed to be free from defects in parts and manufacture for 2 years from the date of purchase, provided that the product is used under the normal operating conditions stated within the manual.
- The warranty is only available to the original purchaser and is not transferable. Your consumer rights are not affected.
- If there are any defects with your hand dryer please contact the provider stating your invoice number, date of purchase, full name and address.
- Do not attempt to repair or take apart the hand dryer your self. If the hand dryer has been tampered with before it arrives with us, the warranty will be void.
- We advise that all customers retain original packaging should the unit need to be returned.
- If your hand dryer occurs a problem outside of the warranty period, we offer a repair service where we can collect and professionally repair your hand dryer.

Notes



Automatic Hand Dryers

Visit www.tekflo.com or email enquiries@tekflo.com
for more information